



Venue : Makuhari Messe

Organizer

International Plastic Fair Association

2-10-18 Ginza, Chuo-ku, Tokyo 104-0061 JAPAN

TEL:+81-3-3542-1487 FAX:+81-3-3543-0619

E-mail: info@ipfjapan.jp http://www.ipfjapan.jp

Overseas Agent

Korea

Bauplas Co. PLASTICS KOREA Magazine

Tel:+82-2-711-3422

Fax:+82-2-716-3307

E-mail: kplastic@chol.com

China & Hong Kong

Adsale Exhibition Services Ltd.

Contact: Ms. Janet Ji / Ms. Chris Xu

Tel:+86 21 51879766 ext. 276 / ext. 212

Fax:+86 21 64693665

E-mail: ipf@adsale.com.hk

Taiwan

Taiwan External Trade Development Council (TAITRA)

Contact: Mr. WANG Shi hui, Market Development Dept.

Tel:+886-2-27255200 #1514

Fax:+886-2-27576017

E-mail: shwang@taitra.org.tw

IPF
JAPAN
2011

The High-Tech Show

INTERNATIONAL PLASTIC FAIR

Venue: **Makuhari Messe**
1 hour from Tokyo Central Station

October 25-29, 2011

www.ipfjapan.jp

EXHIBITING PROSPECTUS Organizer: IPF Association

Plastic Molding Machines & System Expo

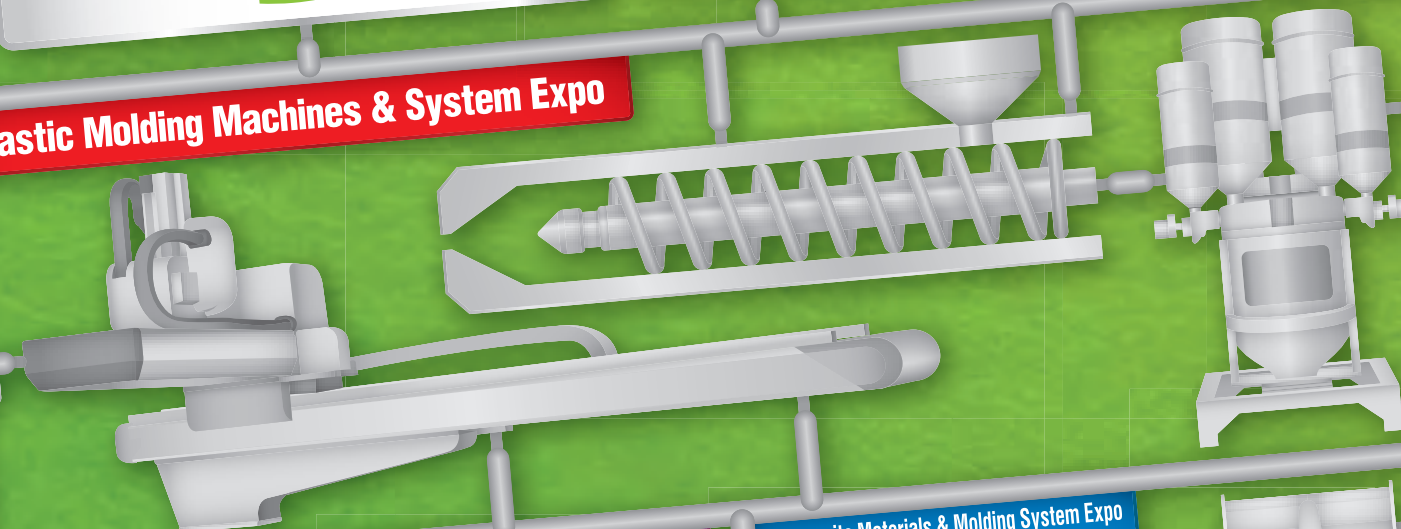

High-performance Raw Materials, Additives & Fillers Expo

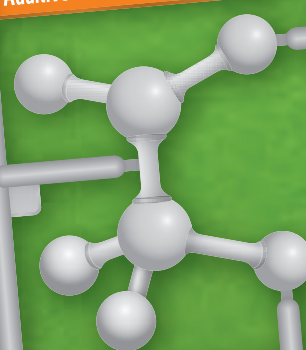

Contracted Manufacturing & Processing Service Expo



Composite Materials & Molding System Expo
-FRP & CFRP & FRTP-



Rubber Materials & Molding System Expo

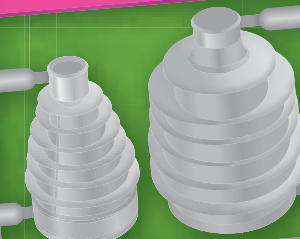

Recycling Equipment Expo



Mold Design & Manufacturing System Expo for Plastic & Rubber



Multi-joint Robot Zone

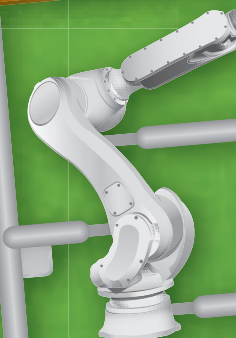

Foamed Plastic Expo



IPF JAPAN is the assembly of specialized trade shows which covers every process of plastic and rubber molding.

“Win the battle among materials! –Beat metals, glasses and ceramics–”

High-performance Raw Materials, Additives & Fillers Expo

Exhibitor
Raw materials, additives & fillers makers

Target User
Product designer of automobile and electronic devices, Plastic molders and processors

Special Theme Silicon corner, Bioplastics corner

“Seek the ultimate performance”

Plastic Molding Machines & System Expo

①Injection Zone ②Extrusion Zone (Special Theme: Film Processing Corner) ③Blow & Bottle Zone
④Thermoforming & Other Molding Zone ⑤Ancillary Equipment Zone ⑥Secondary Processing Zone
⑦Parts & Component Zone ⑧Controller & Measuring Equipment Zone ⑨Factory Facilities Zone

Exhibitor
Molding machines makers, Parts makers, Ancillary equipment makers, Plant facility makers

Target User
Plastic molders and processors

“Zero defects production starts from here”

Mold Design & Manufacturing System Expo for Plastic & Rubber

Exhibitor
Machine tool makers, CAD/CAM and flow simulation software makers, Mold base/parts makers, Mold repair tool makers, Mold clumping system makers, Hot runner makers

Target User
Mold manufactures, Mold designers

“Future of Rubber”

Rubber Materials & Molding System Expo

Exhibitor
Rubber raw materials makers, Rubber molding & processing machines makers

Target User
Rubber molders and processors

Special Theme TPE corner

“Saving weight & expanding application”

Composite Materials & Molding System Expo –FRP & CFRP & FRTP–

Exhibitor
Thermosets makers, Filler makers, Composite processing machines makers

Target User
Automobile makers, Airplane makers, Electronics parts makers

“Foam opens new era”

Foamed Plastic Expo

Exhibitor
Foam raw material makers, Foam molding machine makers, Foam processing machine makers, Foam products

Target User
Form molders and processors

Co-organizer Foam Times Co., Ltd.

“Automation create additional value!”

Multi-joint Robot Zone

Exhibitor
Multi-joint robot makers

Target User
Molders and processors who want to improve productivity and lower labor cost

“Eco-friendly is compatible with business-friendly”

Recycling Equipment Expo

Exhibitor
Recycling equipment makers

Target User
Molders, Recycling Company

“Can you sell your skills and know-hows?”

Contracted Manufacturing & Processing Service Expo

①Industrial Component & Medical Device Zone ②Secondary Processing Zone –Printing & Decorating & Cutting & Welding– ③Mold Manufacturing Zone ④Design & Prototyping & Manufacturing Support Zone

Exhibitor
Contracted manufacturing and processing companies, Prototype design and production companies, Molders and processors

Target User
Procurement manager of automobile makers, Electronics appliances makers, Medical device makers



IPF Japan 2011 Show Profile

Title: IPF Japan 2011 (International Plastic Fair) [7th IPF since 1994]

Date: Oct. 25 – 29, 2011 5Days

Show Hours: 10:00 – 17:00 [Last day: 16:00]

Venue: Makuhari Messe (1 hour from Tokyo Central Station)
<http://www.m-messe.co.jp/en/access/index.html>

Organizer: International Plastic Fair Association

Support: Ministry of Economy, Trade and Industry/
 Japan External Trade Organization (JETRO) (application scheduled)

Cooperation: Major Plastic and Rubber Associations

Scale: Exhibitors : 993, No. of Booth : 2,878
 (Net: about 25,000sqm.) (IPF2008)

Visitors: 66,642 (IPF2008)

Entrance Fee: Free for pre-registrant through IPF website
 JPY ¥ 1,000 for on-site registration (Good for 5 days)

Cycle: Once every 3 years

Schedule

Deadline of Space Reservation	April 8, 2011
Payment Deadline of Exhibit Space Fee	May 31
Exhibitor's Manual and Booth Layout (Floor Plan) will be sent to exhibitors	Early June
Power Cable & Water Pipe Construction by Organizer	October 20
Move-in & Booth Decoration by Exhibitors	October 21-24
Show Period	October 25-29
Move-out	October 30

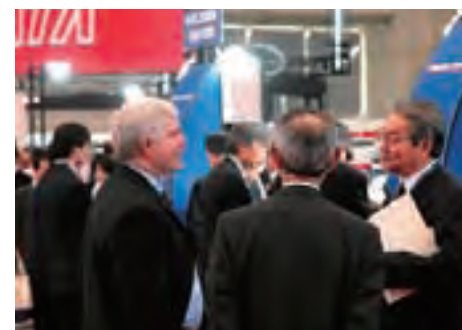

IPF JAPAN 2008 Show Report

IPF JAPAN is the only plastic & rubber trade show in Japan, which attracts professionals in the industry from all over Japan and Asia.

Visitors

	Japanese	Overseas	Total
IPF2008	62,762	3,880	66,642

Industry Segments

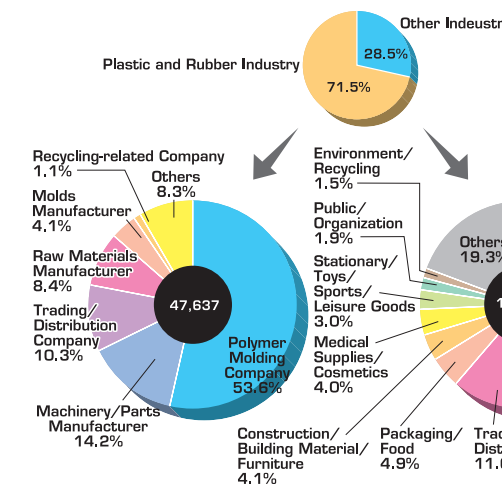

Japanese Visitors by Region [62,762]

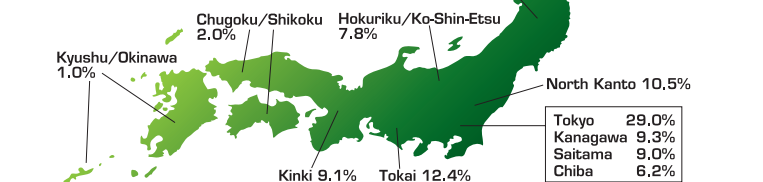

Overseas Visitors by Region [3,880]

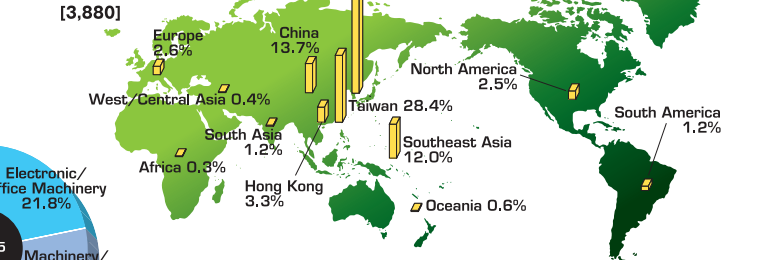

KOREA	1,310	PHILIPPINES	38	AUSTRALIA	6	SRI LANKA	4	BELGIUM	1
TAIWAN	1,100	GERMANY	36	FRANCE	6	SWEDEN	4	FIJI	1
CHINA	530	INDIA	36	MYANMAR	6	AUSTRIA	3	FINLAND	1
THAILAND	215	MEXICO	29	NETHERLANDS	5	BANGLADESH	3	IRAN	1
HONG KONG	129	NEW ZEALAND	16	SOUTH AFRICA	5	DENMARK	3	LUXEMBOURG	1
USA	85	ITALY	15	PAKISTAN	5	KAZAKHSTAN	3	RUSSIA	1
MALAYSIA	74	CANADA	13	UAE	5	POLAND	3	SLOVAKIA	1
SINGAPORE	53	BRAZIL	10	ALGERIA	4	SAUDI ARABIA	3	SWISS	1
VIETNAM	44	SPAIN	10	COLOMBIA	4	TURKEY	3	SYRIA	1
INDONESIA	38	UK	9	EGYPT	4	ALGERIA	1	TUNISIA	1

(3,880 People from 50 Countries and Regions)

Function

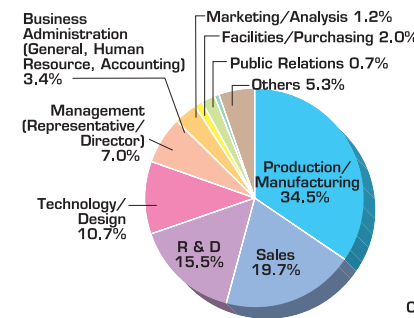

Position

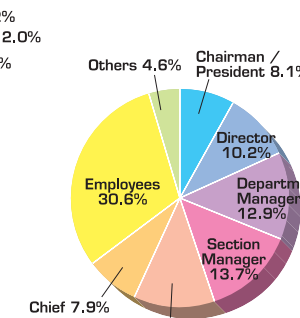

Purchasing Decision

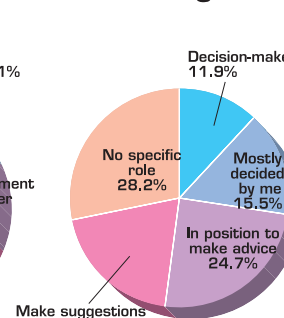

Company Size

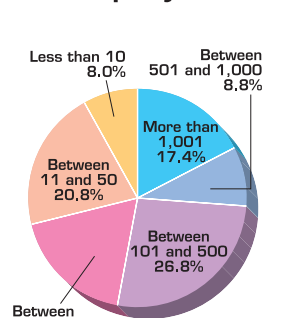

Exhibitors

Scale of Exhibition

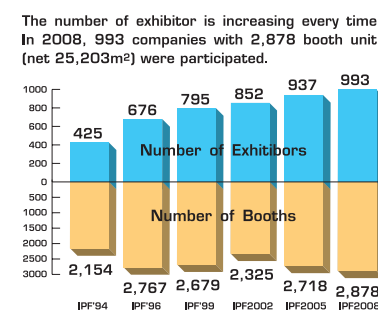

Breakdown by Nation

Country/Region	Exhibitors	Country/Region	Exhibitors
JAPAN	596	HONG KONG	6
GERMANY	82	INDIA	3
USA	62	CANADA	3
TAIWAN	53	SPAIN	3
CHINA	46	THAILAND	3
ITALY	31	DENMARK	3
KOREA	24	ISRAEL	2
SWISS	18	SINGAPORE	2
AUSTRIA	18	VIETNAM	2
FRANCE	15	SWEDEN	1
UK	12	CZECH	1
NETHERLANDS	6	MALAYSIA	1

Note: Number of company includes co-exhibitors and exhibit's manufacturers.

Breakdown by Product Classification

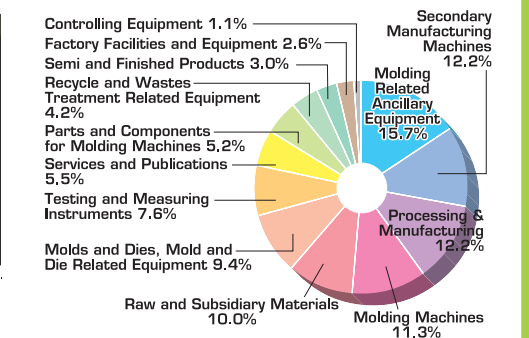

These are short list of the people you can expect to meet at IPF JAPAN. You will meet your potential customers, such as world-known Japanese car makers and electrical appliances makers and small but high-tech companies.

Medical Devices and Materials

ASAHI INTECC
 COVIDIEN GROUP JAPAN
 CREATE MEDIC
 FUKOKU
 GE YOKOGAWA MEDICAL SYSTEM
 HIRAKAWA HEWTECH
 HOYA
 JMS
 KANEKO CORD
 KAWASUMI LABORATORIES
 NIHON KOHDEN
 NIKKISO
 NIPRO
 NIPRO MEDICAL INDUSTRIES
 NIPRO PHARMA
 OLYMPUS MEDICAL SYSTEMS
 PIOLAX
 SEED
 TANITA
 TEIJIN PHARMA
 TERUMO
 TOMEY
 TOPCON
 TOYOBO

Industrial Parts and Components

(Mechanical Parts, Gears, Film, Optical Parts, Electric Cables, Hoses, etc.)

ACHILLES
 ASAHI GLASS
 BANDO DENSEN
 BRIDGESTONE
 C. I. KASEI
 DAI NIPPON PRINTING
 DAIICHI SEIKO
 DIC
 ENPLAS
 FUJIKURA
 FUJIKURA RUBBER
 FUJIMORI KOGYO
 FURUKAWA BATTERY
 FURUKAWA ELECTRIC
 FUTAMURA CHEMICAL
 GIFU PLASTIC INDUSTRY
 HITACHI CHEMICAL COMPANY
 HITACHI HIGH-TECH MANUFACTURING & SERVICE
 HOYA
 INOAC
 J-POWER SYSTEMS
 JSP
 KODAMA CHEMICAL INDUSTRY
 KOKOKU INTECH
 KONICA MINOLTA OPTO
 KYODO PRINTING
 LINTEC
 MITSUBISHI CABLE INDUSTRIES

MITSUBISHI GAS CHEMICAL
 MITSUBISHI PLASTICS
 MURATA MANUFACTURING
 NANBU PLASTICS
 NICHIAS
 NIDEC COPAL
 NIFCO
 NIKON
 NIPPON SEIKI
 NISHIKAWA RUBBER
 NISSHO
 NITTA
 NITTO DENKO
 NITTOH KOGAKU
 NOK
 OKI ELECTRIC CABLE
 OKURA INDUSTRIAL
 OLYMPUS
 OLYMPUS OPTO-TECHNOLOGY
 PACIFIC INDUSTRIAL
 PIOLAX
 SANKO
 SANWA KAKO
 SEKISUI CHEMICAL
 SHIN-KOBE ELECTRIC MACHINERY
 STANLEY
 SUMITOMO ELECTRIC INDUSTRIES
 SUMITOMO WIRING SYSTEMS
 SUNARROW
 TAKAGISEIKO
 TAMRON
 TDK
 TEIJIN DUPONT FILMS JAPAN
 TENMA
 THE NIPPON SYNTHETIC CHEMICAL INDUSTRY
 TOKAI RUBBER INDUSTRIES
 TORAY INDUSTRIES
 TOYOBO
 UCHIYAMA MANUFACTURING
 YKK

Automobiles, Airplanes, Ships

AISIN AW
 AISIN CHEMICAL
 AISIN SEIKI
 ALPINE ELECTRONICS
 ASMO
 AUTOLIV
 BOSCH
 BRIDGESTONE
 CALSONIC KANSEI
 CENTRAL MOTOR
 CLARION
 DAIHATSU MOTOR
 DAIKONISHIKAWA
 DENSO

DENSOTECHNO
 ENPLAS
 FALTEC
 FTS
 FUJI HEAVY INDUSTRIES
 GS YUASA CORPORATION
 GS YUASA POWER SUPPLY
 HAYASHI TELEMPU
 HINO MOTORS
 HITACHI
 HITACHI CAR ENGINEERING
 HONDA ENGINEERING
 HONDA LOCK
 HONDA MOTOR
 HONDA R&D
 ICHIKOH INDUSTRIES
 IHI AEROSPACE
 ISUZU MOTORS
 JAMCO CORPORATION
 KANTO AUTO WORKS
 KASAI KOGYO
 KEIHIN
 KINUGAWA RUBBER INDUSTRIAL
 KOITO MANUFACTURING
 KOJIMA PRESS INDUSTRY
 KYB
 KYOSAN DENKI
 MAZDA MOTOR
 MICHELIN RESEARCH ASIA
 MITSUBA
 MITSUBISHI AUTOMOTIVE ENGINEERING
 MITSUBISHI MOTORS
 MORIROKU
 MURAKAMI CORPORATION
 NHK SPRING
 NICHIRIN
 NISSAN MOTOR
 NISSAN SHATAI
 ROKI
 SAKAE RIKEN KOGYO
 SAKAMOTO INDUSTRY
 SANOH INDUSTRIAL
 SHOWA
 SUZUKI MOTOR
 TACHI-S
 TAKAGI SEIKO
 TOKAIRIKA
 TOYODA IRON WORKS
 TOYOTA AUTO BODY
 TOYOTA BOSHOKU
 TOYOTA CENTRAL R&D LABS
 TOYOTA GOSEI
 TOYOTA INDUSTRIES
 TOYOTA MOTOR
 TOYOTA MOTOR KYUSHU
 TS TECH
 TSUBAKIMOTO CHAIN

TSUDA INDUSTRIES
 UNIPRES
 YACHIYO INDUSTRY
 YAMAHA MOTOR
 YAZAKI
 YOKOHAMA RUBBER

Housing Equipment and Materials

ARONKASEI
 CLEANUP
 FUKUJI CHEMICAL INDUSTRY
 INAX
 KANAFLEX
 MISAWA HOMES
 MISAWA TECHNO
 NORITZ
 SANKYO TATEYAMA ALUMINIUM
 SEKISUI CHEMICAL
 SHIN NIKKEI COMPANY
 SHIN-ETSU POLYMER
 SUN WAVE
 TOSTEM
 TOTO
 TOTO BATH CREATE
 YAMAHA
 YAMAHA LIVINGTEC
 YKK AP

Electrical and Electronics

ALPS ELECTRIC
 ASTI
 BROTHER INDUSTRIES
 CANON
 CANON CHEMICALS
 CANON COMPONENTS
 CANON FINETECH
 CANON MOLD
 CASIO COMPUTER
 CASIO HITACHI MOBILE COMMUNICATIONS
 CITIZEN ELECTRONICS
 FOSTER ELECTRIC
 FUJI XEROX
 FUJIFILM
 FUJITSU
 FUJITSU GENERAL
 FUJITSU TEN
 HEWLETT-PACKARD JAPAN
 HIROSE ELECTRIC
 HITACHI
 HITACHI APPLIANCES
 HITACHI CABLE PRECISION
 HITACHI DISPLAYS
 HITACHI MAXELL
 HONDA TSUSHIN KOGYO
 IBM JAPAN PROCUREMENT CENTER
 IRISO ELECTRONICS
 J.S.T. MFG.
 JAPAN AVIATION ELECTRONICS INDUSTRY
 KDDI
 KENWOOD
 KONICA MINOLTA BUSINESS TECHNOLOGIES

MITSUBISHI ELECTRIC
 MITSUMI ELECTRIC
 MOLEX
 NEC
 NEC ACCESSTECHNICA
 NEC LCD TECHNOLOGIES
 OKI ELECTRIC INDUSTRY
 OMRON
 OMRON PRECISION TECHNOLOGY
 PANASONIC
 PANASONIC ELECTRIC WORKS
 PANASONIC ELECTRONIC DEVICES
 PHILIPS ELECTRONICS
 POLYMATECH
 RICOH
 SAMSUNG JAPAN
 SEIKO EPSON
 SEIKO INSTRUMENTS
 SEIKO PRECISION
 SHARP
 SHOWA DENKO
 SMK
 SONY
 SONY CHEMICAL & INFORMATION DEVICE
 SONY COMPUTER ENTERTAINMENT
 SONY DISC & DIGITAL SOLUTIONS
 SONY EMCS
 SONY ENERGY DEVICES
 SONY ERICSSON MOBILE COMMUNICATIONS
 SONY MANUFACTURING SYSTEMS
 SONY MUSIC MANUFACTURING
 TOHOKU PIONEER
 TOSHIBA
 TYCO ELECTRONICS AMP
 VICTOR
 YAMAICHI ELECTRONICS
 YOKOGAWA MANUFACTURING

Household Goods, Toys, Stationary, Sports and Leisure

ASICS
 BANDAI
 BRIDGESTONE SPORTS
 CAN DO
 COMBI
 IRIS OHYAMA
 MITSUBISHI PENCIL
 MIZUNO
 P&G JAPAN
 PENTEL
 PILOT
 RISUPACK
 RYOHIN KEIKAKU
 S.T.
 SAKURA COLOR PRODUCTS
 SRI SPORTS
 TABATA
 TOMBOW PENCIL
 YAMAMOTO KOGAKU
 YONEX
 ZEBRA

Packaging, Foods, Drinks and Cosmetics

AJINOMOTO
 AJINOMOTO GENERAL FOODS
 ASAHI BREWERIES
 ASAHI SOFT DRINKS
 BESPACK
 CALPIS
 CHIFURE
 CHUO KAGAKU
 COCA-COLA
 COCA-COLA NATIONAL BEVERAGE
 DAI NIPPON PRINTING
 DAIICHI SANKYO
 DAIWA CAN
 DHC
 DNP TECHNO POLYMER
 FANCL
 FP
 FUKUSUKE KOGYO
 GLICO DAIRY PRODUCTS
 HOKKAICAN
 HOUSE FOODS
 HOWA SANGYO
 JAPAN TUPPERWARE
 KAO
 KEWPIE
 KIRIN BEVERAGE
 KIRIN BREWERY
 KIRIN ENGINEERING
 KRACIE HOLDINGS
 LION
 LOTTE
 MEIJI DAIRIES
 MORINAGA MILK INDUSTRY
 NESTLE JAPAN
 NIHON YAMAMURA GLASS
 NIPPO
 NISSIN FOODS
 NOEVIR
 OTSUKA PHARMACEUTICAL
 PRIMA MEAT PACKERS
 ROHTO PHARMACEUTICAL
 SHISEIDO
 SUNSTAR
 SUNTORY
 TAISEIKAKO
 TOKAN KOGO
 TOPPAN HARIMA PRODUCTS
 TOPPAN PRINTING
 TOYO SEIKAN
 YAKULT HONSHA
 YAMASA
 YOSHINO

Korean companies, such as HYUNDAI MOTOR and SAMSUNG ELECTRONICS was among the visitors, as well as Taiwan EMS majors.

A
01DB-METRAVIB
3D WELDLESS ALLIANCE
ACE MEDIA SERVICE INC.

B
B+M SURFACE SYSTEMS GMBH
B+S
BANDERA LUGI CONSTRUZION MECCANICHE SPA.

C
C F SCHEER & CIE GMBH&CO.KG.
C. A. PICARD JAPAN CO., LTD.

COMPULAST INTERNATIONAL INC.
COMPUTERMATE JAPAN CO., LTD.
CONSULTEC SYSTEMS INC.

E
EAS QUICK MOLD CHANGE
EB TECH CO., LTD.
EBARA JITSUGYO CO., LTD.

F
F&A TECHNOLOGY CO., LTD.
FANUC LTD
FARRAG TECH GMBH

G
G & S CO., LTD.
GABO QUALIMETER TESTANLAGEN GMBH
GALA INDUSTRIES, INC.

I
I O M CO., LTD.
I.T.S. JAPAN CORP.
IKOH ENGINEERING LTD.

J
JAPAN DIE & MOLD INDUSTRY ASSOCIATION
EASTERN DIVISION TENSEIKAI
JAPAN HIGH TECH CO., LTD.

K
K. BRASCH & CO., LTD.
K.K. IRISU
K.K. OSADA SEISAKUSHO LTD.

L
LABTECH ENGINEERING CO., LTD.
LAMBENT TECHNOLOGY CORP.
LASERLINE GMBH

M
M&K CO., LTD.
M.L.MOLDE CO., LTD.
MAAG PUMP SYSTEMS TEXTRON AG.

M
MECASONIC
MEGARO TECHNICA CO., LTD.
MEG-MARUKA MIXING SYSTEM CO., LTD.

N
NACH-FUJIKOSHI CORP.
NAGASE & CO., LTD. INFORMATION & FUNCTIONAL MATERIALS DEPT

O
OCEAN OPTICS CO., LTD.
OCV GRP CO., LTD.
ODAGIRI MATERIAL CO.

P
PAD PRINTER ENGINEERING CO., LTD.
PAIONIA FURYOKUKI CO., LTD.
PALLMANN MASCHINENFABRIK GMBH&CO.KG.

R
RINCO ULTRASONICS AG.
RINGIER TRADE PUBLISHING LTD.
RINK INSTRUMENT

S
S+S SEPARATION AND SORTING TECHNOLOGY GMBH
S&B INNOVATIVE PLASTICS JAPAN LLC
SACMI BIOLA

T
T&K INC.
T.FUKASE AND CO., LTD.
TABATA INDUSTRIAL MACHINERY CO., LTD.

U
UBE INDUSTRIES, LTD.
UBE INFORMATION SYSTEMS, INC.
UBE MACHINERY CO., LTD.

V
VAN DAM MASCHINEN B.V.
VECTRON INTERNATIONAL CO., LTD.
VELP

W
WAIZU CORP.
WEIKON ENGINEERING LTD.
WATANABE SEIKOSHO CO., LTD.

X
XALLOY JAPAN CO., LTD.
XINTECH SYSTEMS AG.
YAMAHA ELECTRONICS CO., LTD.

Z
ZENITH PUMPS/COLFAX CORP.
ZENDI CORP.
ZERMA GMBH

Z
ZEMAX CORP.
ZHUANG JIANGANG BEIER MACHINERY CO., LTD.
ZHANGJIANGANG LANHANG MACHINERY CO., LTD.

T
T&K INC.
T.FUKASE AND CO., LTD.
TABATA INDUSTRIAL MACHINERY CO., LTD.

Y
YAMAHA ELECTRONICS CO., LTD.
YAMAGUCHI SANGYO CO., LTD.
YAMACHI CHEMICAL INDUSTRIES CO., LTD.

1 Standard Booth

Space Fee

One Unit: **¥294,000** / 9m²

2.97m(W) × 2.97m(D) (approx.9m²)

※ The organizer provides dividing walls when one's booth attached to the others. One of the side panels will not be provided for corner booth.

Note Changed from the previous show. Side panel will be set up to the aisle.

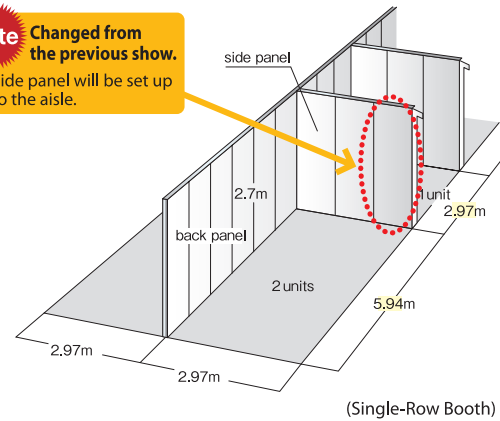

(Single-Row Booth)

Decoration Plan (Option)

※ Space fee is not included.

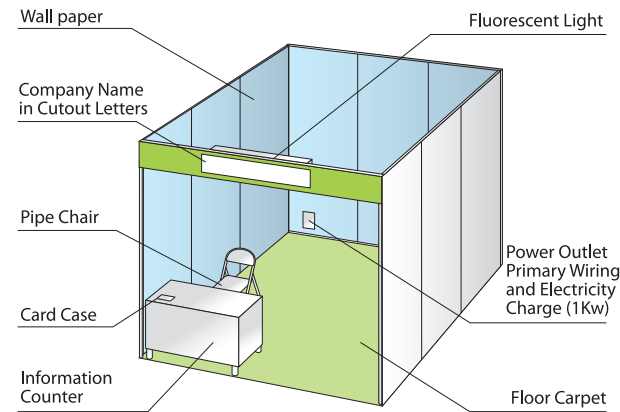

Option Price			
¥105,000	1 unit	¥294,000	4 units (Single)
¥168,000	2 units	¥283,500	4 units (Double)
¥231,000	3 units	¥388,500	6 units (Double)

Please consult the Exhibitor Manual for the details, which will be sent by June 30, 2011. Exhibitors can not order the Packaged Decoration Plan before that time.

2 Catalog Display Stand

Show your presence without hassles

¥105,000 / One Stand

Business cards of those who request your company catalog will be collected on behalf of your company.

Display only. No one is allowed to attend the stand.



Catalog Display Stand

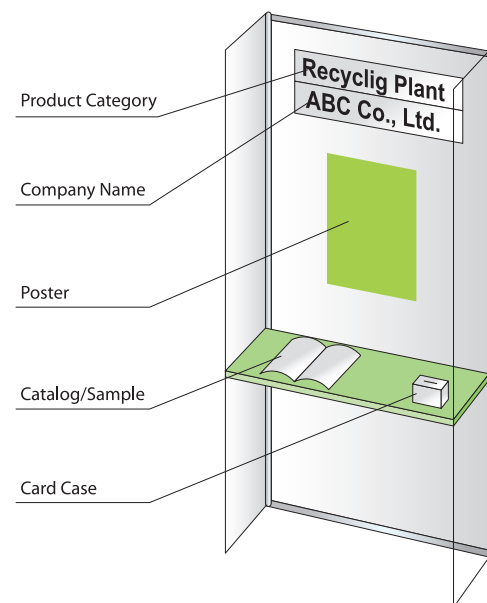

3 Special Booth for Contracted Manufacturing & Processing Service Expo

Who should exhibit

- 1 Industrial Component & Medical Device Zone
- 2 Secondary Processing Zone -Printing & Decorating & Cutting & Welding-
- 3 Mold Manufacturing Zone
- 4 Design & Prototyping & Manufacturing Support Zone

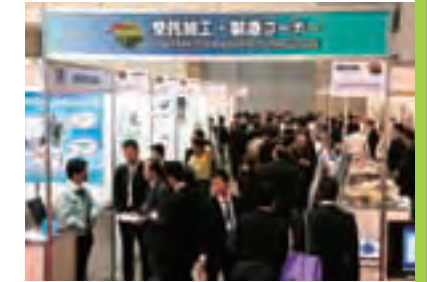

- Plastic & rubber processors
- Coating, printing & assembly
- Waste plastics treatment/disposal
- Electronics manufacturing services (EMS)
- Other business related to the manufacture /processing of plastics and rubber

Note: Machinery and equipment makers can not apply for the Contracted Manufacturing & Processing Service Expo.



Needs of Visitors

Looking for a suppliers ● who has unique skills ● who can make products with low cost

Configuration

Space Fee

One Unit: **¥157,500**

1.98m(W) × 1.98m(D) (approx.4m²)

※ The organizer provides dividing walls when one's booth attached to the others. One of the side panels will not be provided for corner booth.

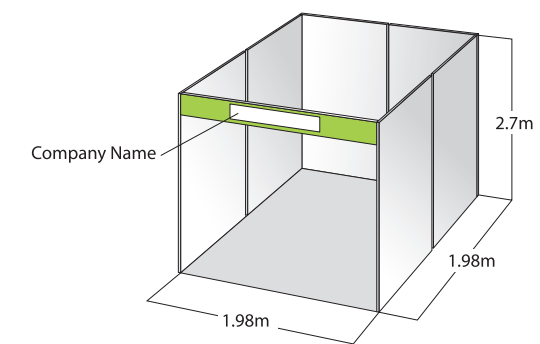

Decoration Plan (Option)

※ Space fee is not included.

Carpet (4m)	¥ 8,400
Display Table (1m×0.5 m)	¥ 8,400
Information Counter	¥ 5,775
Counter Chair	¥ 3,675
Folding Pipe Chair	¥ 630
Folding Table (1.5m wide)	¥ 3,360
Exhibit Shelf (3×2 racks)	¥ 15,750
Catalog Stand (A4)	¥ 5,250
Name Card Box	¥ 1,575
Information Panel (A1Size)	¥30,000~

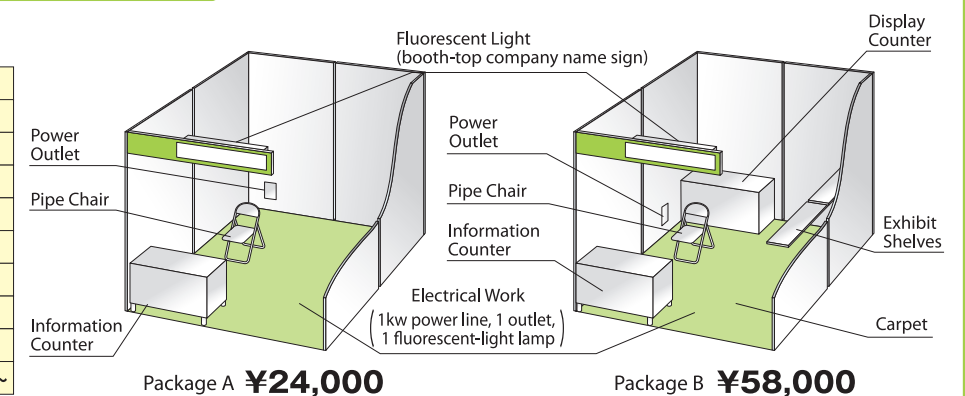

Package A **¥24,000**

Package B **¥58,000**

Exhibitor's Presentation Seminar

Best opportunities to announce your products details.



Seminar Room Fee

50 Seats	¥105,000 / 1 Session
100 Seats	¥157,500 / 1 Session
250 Seats	¥210,000 / 1 Session

Time : 60 min./session

You can apply for consecutive sessions.

Seminar Management

Exhibitors should do the followings by themselves.

- ① Receiving applications from the would-be attendees.
- ② Distributing documents/resume to the attendees.

Official Directory & Internet Advertisement

- Application Deadline : June 30, 2011
- Ad Data Deadline : July 31, 2011

Prices

Formalized Product Advertisement

	1/4 page
Japanese Edition Only	¥105,000
English Edition Only	¥84,000
Both English and Japanese Edition	¥157,500

※ Not including translation fee.

Free Format Advertisement

Position (Color)	Japanese Edition	English Edition
Inside Front Cover (4)	¥840,000	¥420,000
Inside Back Cover (4)	¥472,500	¥231,000
Back Cover (4)	¥997,500	¥525,000
Inside Front Cover Opposite (4)	¥787,500	¥367,500
Inside Back Cover Opposite (1)	¥315,000	¥157,500
Full Color (4)	¥420,000	¥210,000
Black & Blue (2)	¥315,000	¥157,500
Black Only (1)	¥210,000	¥105,000

※ Size : A4 297mm x 210mm

Open to Public on Internet
Sep. 15, 2011

Media Profile

- Date of Issue : Oct. 24, 2011
- Size : A4
- Contents :
 - ① Floor Map
 - ② Seminar Schedule
 - ③ List of Exhibiting Company
- Number of Copies :
 - Japanese 70,000 Copies
 - English 10,000 Copies
- Distribution : Free at the entrance

Official Directory

Exhibitors List

3D WELDLESS ALLIANCE WELDLESS WELDING EQUIPMENT MANUFACTURER AND SERVICE CENTER FOR THE WORLD WIDE MARKET. TEMPERATURE ANALYZER/METROLOGICAL CALIBRATION/EQUIPMENT/QUALITY MANAGEMENT. TEL: 41-0435-5154 FAX: 41-0435-4280 URL: http://www.3dwa.com	BOOTH NO. 81608
CHITUBUSHI CORPORATION TECHNICS TEL: 0424-524242 FAX: 0424-524259 URL: http://www.chitubushi.com CS&C INNOVATIVE PLASTICS JAPAN LLC TEL: 0424-524242 FAX: 0424-524259 URL: http://www.chitubushi.com FUJIBURO CO., LTD. TEL: 0424-524242 FAX: 0424-524259 URL: http://www.chitubushi.com MAKINO MOLDING MACHINE CO., LTD. TEL: 0424-524242 FAX: 0424-524259 URL: http://www.chitubushi.com KAJIKEN GENCO INC. TEL: 0424-524242 FAX: 0424-524259 URL: http://www.chitubushi.com UVEL CORP. TEL: 0424-524242 FAX: 0424-524259 URL: http://www.chitubushi.com HITACHI METALS LTD. TEL: 0424-524242 FAX: 0424-524259 URL: http://www.chitubushi.com MORI CO., LTD. TEL: 0424-524242 FAX: 0424-524259 URL: http://www.chitubushi.com MOLDFLOW JAPAN K.K. TEL: 0424-524242 FAX: 0424-524259 URL: http://www.chitubushi.com CAJAE SOLUTION INC. TEL: 0424-524242 FAX: 0424-524259 URL: http://www.chitubushi.com MIRAI CO., LTD. TEL: 0424-524242 FAX: 0424-524259 URL: http://www.chitubushi.com MEIKO MACHINE TOOL, INC. TEL: 0424-524242 FAX: 0424-524259 URL: http://www.chitubushi.com	
ACHILLES CORP. REACTOR/ELECTRON SOLID STATE REACTOR/REACTOR SYSTEMS TEL: 41-0435-5154 FAX: 41-0435-4280 URL: http://www.3dwa.com	4C14
ACO CO., LTD. FOREIGN METALS REMOVING EQUIPMENT/SORTING AND SEPARATING EQUIPMENT/DEWATERING EQUIPMENT/EXTRACTOR TEL: 41-0435-5154 FAX: 41-0435-4280 URL: http://www.3dwa.com	20407
ACTAC CO., LTD. ADVANCED METEOROLOGICAL MEASUREMENT/INNOVATIVE SPEED MEASUREMENT/ HIGH PRESSURE REACTOR/REACTOR SYSTEMS TEL: 41-0435-5154 FAX: 41-0435-4280 URL: http://www.3dwa.com	50315
ADSALE PUBLISHING LTD. - CHINA PLASTIC & RUBBER JOURNAL ADSALE PUBLISHING LTD. TEL: 41-0435-5154 FAX: 41-0435-4280 URL: http://www.3dwa.com	2005
AIC INC. TEL: 41-0435-5154 FAX: 41-0435-4280 URL: http://www.3dwa.com	81403
AIMEX CO., LTD. CORPORATE SERVICES AND SUPPORT SERVICES EQUIPMENT/REACTOR/REACTOR SYSTEMS AND CHEMICAL/PLASTIC/REACTOR/REACTOR SYSTEMS TEL: 41-0435-5154 FAX: 41-0435-4280 URL: http://www.3dwa.com	30410
AKASHI PLASTICS INDUSTRY CO., LTD. TEL: 41-0435-5154 FAX: 41-0435-4280 URL: http://www.3dwa.com	4M207
AKEBONO MACHINE INDUSTRIES CO., LTD. TEL: 41-0435-5154 FAX: 41-0435-4280 URL: http://www.3dwa.com	71209
ALEX CORP. WORLDWIDE WELDING EQUIPMENT MANUFACTURER AND SERVICE CENTER FOR THE WORLD WIDE MARKET. TEMPERATURE ANALYZER/METROLOGICAL CALIBRATION/EQUIPMENT/QUALITY MANAGEMENT/POWER TOOL TEL: 41-0435-5154 FAX: 41-0435-4280 URL: http://www.3dwa.com	10108

Product Advertisement

Molding Machine

Direct Heatcon® Injection Stretch-Blow Molding Machines/SBIII AOKI Series AOKI TECHNICAL LABORATORY, INC.
TEL: 41-0435-5154 URL: http://www.aoki.co.jp
 BOOTH NO. **81211** |

Injection Molding Machine / Liquid Material Injection system ARBURG JAPAN OFFICE
TEL: 41-0435-5154 URL: http://www.arburg.com
 BOOTH NO. **71903** |

EXTRUSION SECTION/EXTRUSION PLANTS FOR T-DIE FILMS AND SHEETS BANDERA LUGI CONSTRUCTION MACHINERY SDA
TEL: 41-0435-5154 URL: http://www.bandera.com
 BOOTH NO. **30110** |

Twin Screw Extruder/ZSK MEGA Volume PLUS COPPERMILL K.K.
TEL: 41-0435-5154 URL: http://www.zsk.com
 BOOTH NO. **11104** |

Official Website

Top

Exhibitor Search

Details

NISSEI PLASTIC INDUSTRIAL CO., LTD.
2110 MINAMIO, SAKAKI-MACHU, HANDEI-HINA-GUN, NAGANO 389-0693
TEL: 0268-81-1008 FAX: 0268-81-1551
URL: http://www.nissei-plastic.co.jp/ E-Mail: info@nissei-plastic.co.jp

Hybrid Type Compact Injection Molding Machine / NPX7-1F NISSEI PLASTIC INDUSTRIAL CO., LTD.
TEL: 0268-81-1008 FAX: 0268-81-1551

IPF JAPAN 2011 GENERAL REGULATIONS

1. Qualification

- ① Applicant must be a company/organization who is in plastic or rubber business.
- ② Machinery and equipment makers can not apply for the Contracted Manufacturing & Processing Service Expo.

2. Exhibit Space Fee Includes

- ① Exhibit space.
- ② Booth dividing walls when one's booth is attached to the others.
- ③ Expenses for promotion and management of IPF JAPAN.

3. Not Included in the Exhibit Space Fee

- ① Booth decorating and operating expenses.
- ② Installation and usage fee of electricity, water, internet line and other utilities.
- ③ Damage insurance for the exhibits, etc.
- ④ Expenses for injuries arising during exhibition or while transporting equipment, etc.
- ⑤ Renovating exhibits and decorations, etc., required by regulations and exhibition rules.
- ⑥ Guidebook advertising fee.
- ⑦ Other expenses not included in the booth fee.

4. Cancellation - Exhibit Space

Exhibitor should submit a notification in writing to the Organizer for approval of cancellation. The following cancellation fee will apply. In the event that the exhibitor has not yet remitted the proper amount as noted below, the exhibitor will remit it immediately. If the exhibitor has already remitted more than the amount noted below, the excess amount will be refunded by the Organizer.

Date of Cancellation	Cancellation Fee
From April 9 to May 31, 2011	50% of the applied exhibit space fee
On or After June 1, 2011	100% of the applied exhibit space fee

5. Cancellation - Seminar

Exhibitors should submit a notification in writing to the Organizer for approval of cancellation. The following cancellation fee will apply.

Date of Cancellation	Cancellation Fee
From June 1 to July 31, 2011	50% of the applied seminar fee
On or After August 1, 2011	100% of the applied seminar fee

6. Cancellation – Advertisement

Exhibitors should submit a notification in writing to the Organizer for approval of cancellation. The following cancellation fee will apply.

Date of Cancellation	Cancellation Fee
From July 1 to September 15, 2011	50% of the applied advertising fee
On or After September 16, 2011	100% of the applied advertising fee

7. Booth Allotment

The Organizer will allot booths taking the following into consideration: the overall zoning plan, the type and scale of exhibits, demonstration plans and application date, etc.

8. Prohibition of Reselling or Renting Exhibit Space

Exhibitor must not rent, resell, exchange, or sell its exhibit space to the other, without obtaining permission from the Organizer.

9. Installation and Removal of Exhibiting Materials

- (1) Transportation and installation of exhibiting materials must be carried out during the specific period designated by the Organizer. The facilities within the booth must be installed before 4 p.m. of the previous day of the exhibition's first day. The Organizer reserves the right to dispose of the exhibit space in whatever manner the Organizer thinks appropriate, if the exhibitor does not install the exhibiting materials by the above time and date. If this happens, the exhibitor must pay the designated cancellation fee (100% of the exhibit space fee) to the Organizer.
- (2) If the exhibitor must remove, move, or transport the exhibiting materials from its booth during the period of the exhibition, the exhibitor must obtain permission of the Organizer before commencement of such activities.
- (3) The exhibiting materials must be removed from the booth by 12 p.m. of the following day of the exhibition's last day. The exhibiting materials left within the booth after this time and date will be removed by the Organizer at the exhibitor's expense.

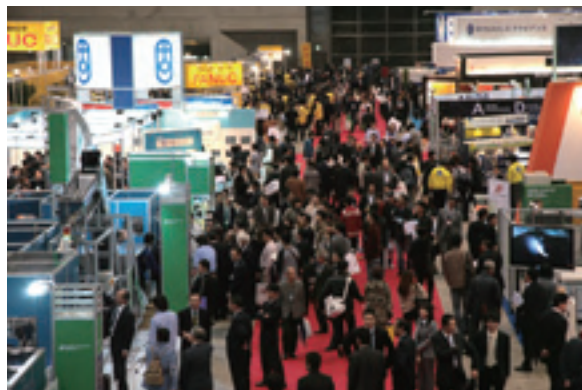

10. Use of the Exhibition Space

- (1) The exhibitor should exhibit the products which fulfill the purposes of this exhibition.
- (2) The exhibitor should make demonstrations or any other PR activities within its own booth.
- (3) The exhibitor should carefully design its booth for not hindering the neighboring exhibitors.
- (4) The Organizer reserves the right to put restrictions on or to prohibit or to remove the exhibits of which sound, handling methods, materials or any other things are deemed unsuitable for the exhibition purposes from the Organizer's viewpoint. This right will extend to persons, articles, printed materials and any other things which the Organizer deems unsuitable. In case of the said restriction or removal, the Organizer will not be responsible for any payment.
- (5) On-site cash deals without the Organizer's approval are prohibited.
- (6) Two-story booth is prohibited.

11. Custody and Protection of Exhibits

The Organizer will take security measures such as hiring security guards for custody and protection of exhibits at the site; but will not be liable for damages or any other compensation for fire, theft, loss, damage or any other accident.

12. Damage Compensation

The exhibitor will be responsible for any or all damages caused by the carelessness of himself or his agents to exhibition, facilities, materials, building, or people.

13. Indemnity

The Organizer may by his own judgment postpone or cancel the exhibition due to circumstances beyond his control. The Organizer will, however, not indemnify any other expenses incurred to exhibitors.

14. Other Rules

Other rules and regulations will be in the exhibitor's manual which will be sent later.

15. Exhibition Contract

The exhibition contract will go into effect upon acceptance of the application form by the Organizer.



FAQ

Q: Can we (exhibitor) choose our booth location?

A: No. Exhibitors cannot choose its specific location. The Organizer will allot booths of all exhibitors, taking the following into consideration: the overall zoning plan, the type and scale of exhibits, demonstration plans and application date, etc. Larger booth and earlier application will be favorably considered. Exhibitors can submit its request about booth location to the Organizer by filling the column on the application form. The Organizer will take the request into consideration, however not be bound by it.

Q: Can we remit the fee with US dollars, Euro or RMB?

A: The Organizer asks exhibitors to send a remittance by Japanese Yen. However, if exhibitor finds it difficult to remit the amount in Japanese Yen due to local government law or regulation, please consult to the Organizer.

Q: We have not decided if we run the machines for demonstration. So we are not sure if we need to receive water supply to our booth.

A: If you have a plan to run your machines, please check the designated column. The Organizer will allocate your booth near the water pipe pit. No cancellation fee will be charged at this stage. You need to send an formal application for water supply to the water pipework company later.